

**PROJECT SYNOPSIS**

All Saints Catholic College is a mainstream secondary school that has an existing capacity for 750 pupils. The school is currently a five form of entry school for Y7-Y11 / 11-16 year old students. The school wishes to increase their capacity by one form of entry (1FE) so they may accommodate additional pupil numbers. Works to the existing school building will be required to facilitate the 1FE expansion; enabling the school to meet the increasing demand for secondary school places within the borough.

The Royal Borough of Kensington and Chelsea have appointed 3BM to deliver design consultation in connection with the 1FE expansion of All Saints Catholic College. 3BM have worked in consultation with the Client and End-User to explore options and how the school could expand by one form of entry, from 750 students to 900 students.

3BM have worked closely with the school to develop a solution that can accommodate the increasing number of students whilst having a minimal impact on the existing buildings and respecting the existing amount of available outdoor space.

The proposed works comprise a new extension block, facade overhaul and the refurbishment of existing areas within the school. The site plans below indicate the areas of the All Saints Catholic College site that are proposed to undergo construction/alteration works to facilitate the 1FE expansion.

- Zone 1 - 1FE Expansion block and refurbishment of existing adjacent areas
- Zone 2 - Re-configuration of the reception area
- Zone 3 - Expansion of existing dining hall space
- Zone 4 - Re-purpose of dance studio
- Zone 5 - Existing facade renovation

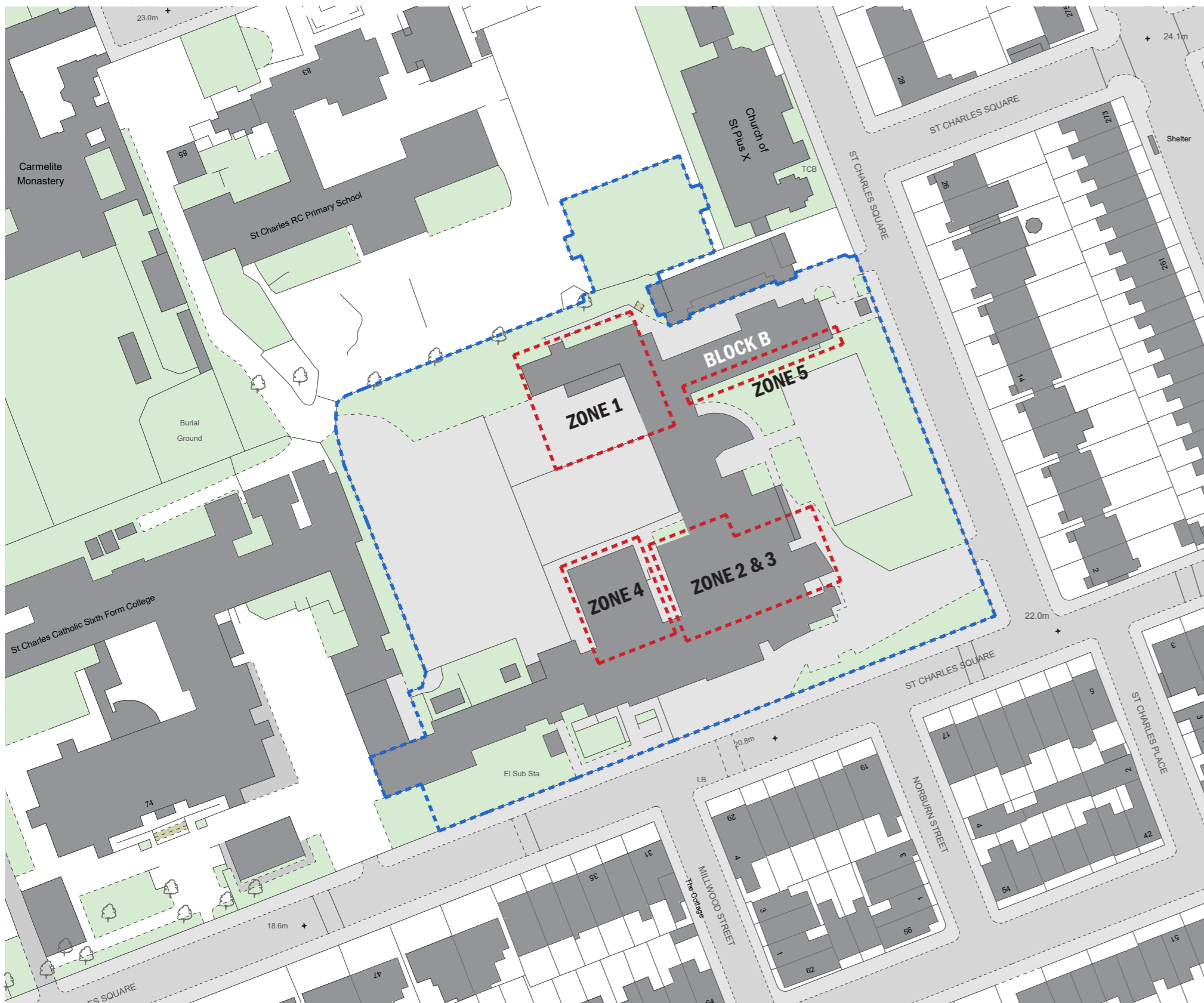

Existing Site Plan

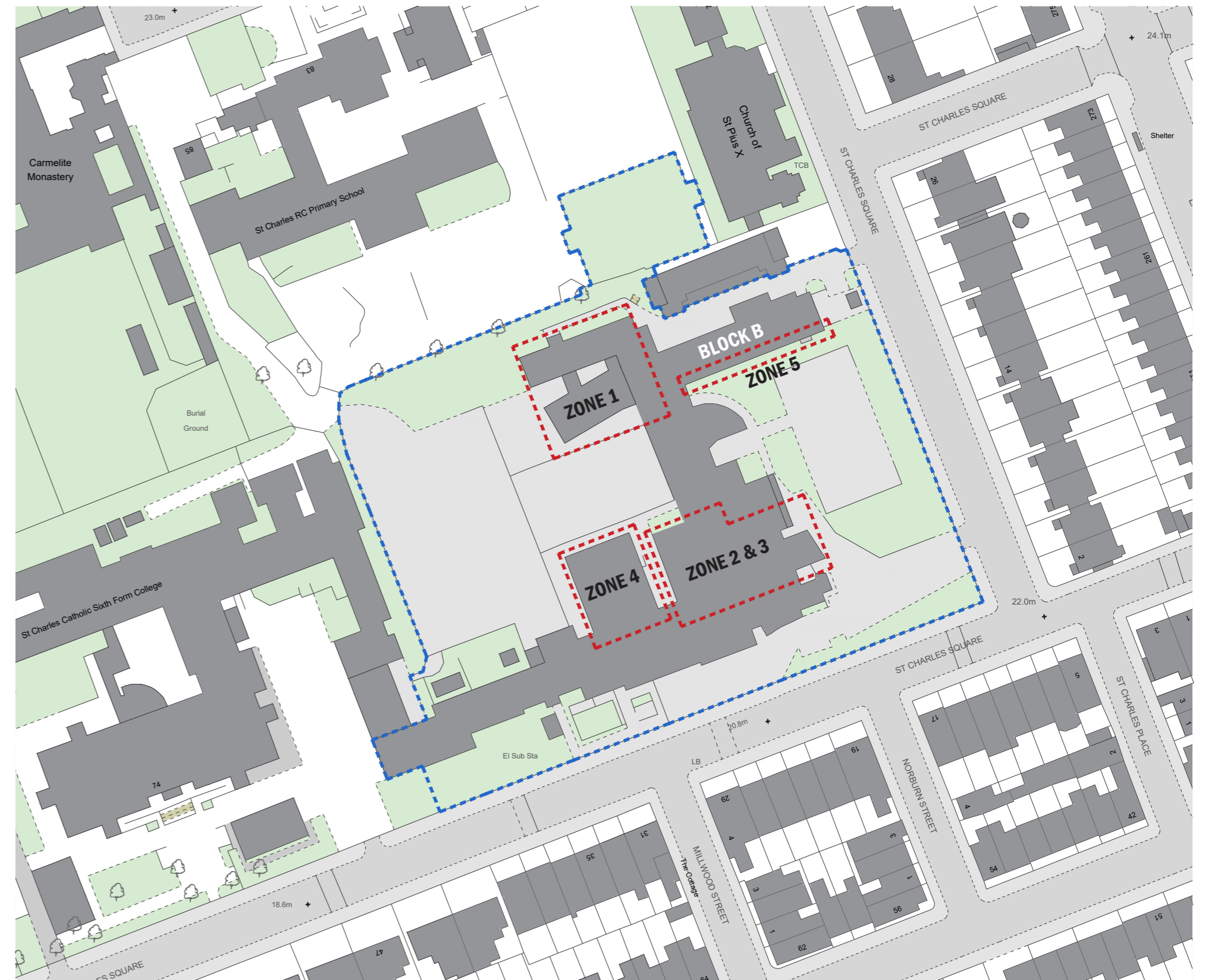

Proposed Site Plan

**THE EXISTING SITE**

The site presents a series of conditions that have informed which areas are most suitable for the location of the expansion block. The developable areas have been determined by considering the available space adjacent to the existing building. These are located in the centre of the site, away from the neighbouring residential areas. Additionally, the existing building, along with the belt of greenery surrounding the site, creates a barrier that improves the privacy and noise transfer between the site and adjacent properties. These central areas of the site are deemed to be the most favourable location in which to position the expansion block.

One of the main determining factors in the shape and placement of the expansion block is the need to respect the existing square-metres of outdoor space. This implies that the available amount of outdoor spaces shall not be affected by the new development.



Existing Site Photograph - Developable area adjacent to Block B



Existing Site Photograph - Existing Facade Condition

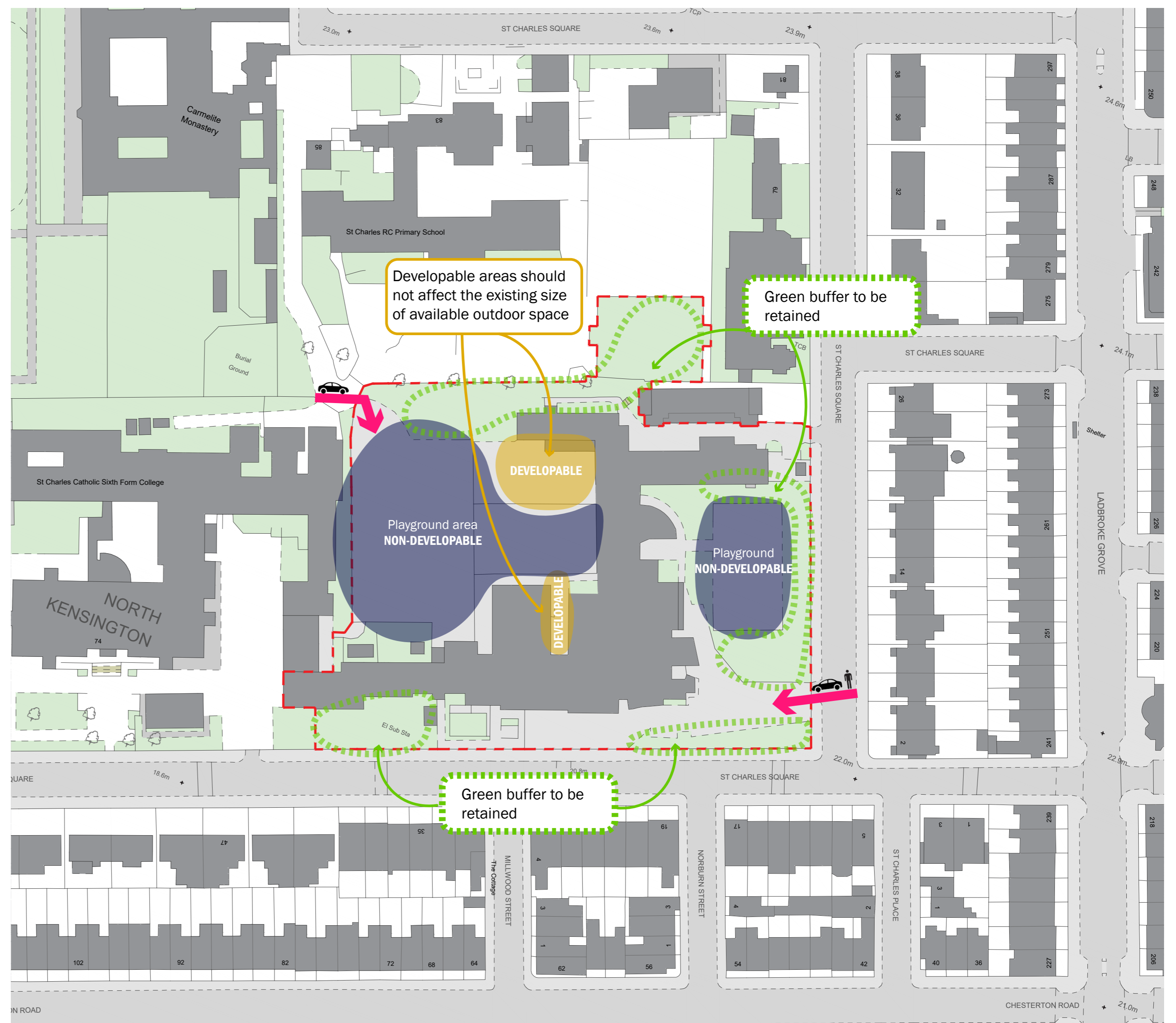

Opportunities and Constraints

**SUMMARY OF WORKS**

Construction, reconfiguration and refurbishment works are proposed to be undertaken at All Saints Catholic College to facilitate the expansion by one form of entry. This is in response to increased popularity of the school and demand for secondary school places within the borough. The expansion will allow a capacity increase of 150 pupils; allowing the school to grow from 750 students to 900 students.

There are four overarching objectives associated with the proposed works which align with the aspirations and growth of the school moving forward. These are to:

- 01 Increase the school's capacity to expand by one form of entry
- 02 Improve the main access to the building
- 03 Offer a larger and more efficient dining area to align with demand of increased pupil numbers
- 04 Unify the external appearance of the buildings on site

3BM Studio has analysed the existing site and identified proposed zones for intervention to fulfil the four key objectives. The following interventions are proposed:

- A new extension block with 6 new classrooms - two of the classrooms to offer maximum flexibility
- Rearrangement of the reception to enhance circulation efficiency and access to the site
- Expansion of the dining space to increase its capacity and improve its functionality
- Redesigning the existing hall to become a flexible space that can be used for dining and other activities
- Re-purpose of the existing dance hall and changing rooms to accommodate staff rooms
- Renovation of existing Block B South Elevation to ensure a unified aesthetic throughout the site



Dining area and reception space



Existing student services



Existing Stage

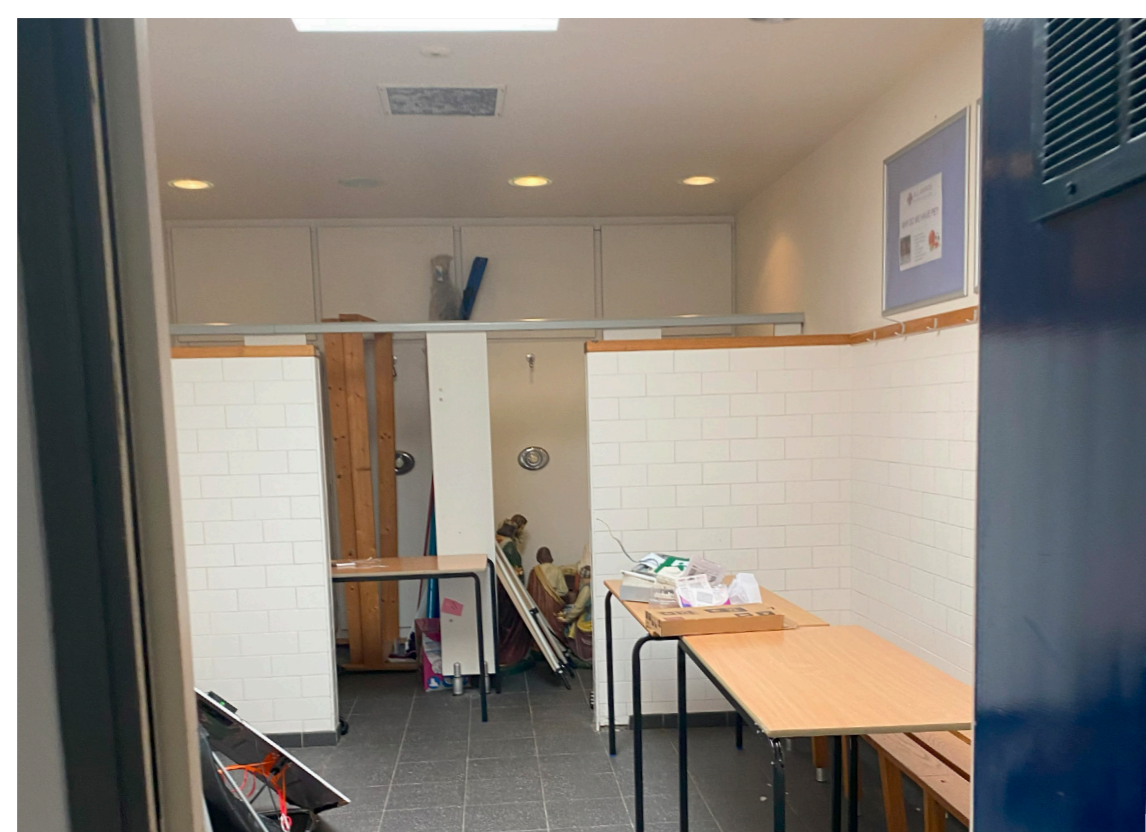

Existing changing facilities

In order for the school to undergo a 1FE expansion, the school will need additional floor area in order to accommodate the new pupil numbers. The required increase in gross internal area is 540m<sup>2</sup>. It is proposed for the additional area to be accommodated within a new extension, adjoining the northernmost part of the existing school building. This extension will be accessed from the existing building and will face into the school playground.

The other zones identified for intervention within the building are necessary to support the expansion and increased pupil numbers.

The diagrams below show the proposed areas of intervention divided into the following zones:

- Zone 1 - 1FE Expansion block and refurbishment of existing adjacent areas
- Zone 2 - Reconfiguration of the reception area
- Zone 3 - Expansion of existing dining hall space
- Zone 4 - Re-purpose of dance studio
- Zone 5 - Existing facade renovation

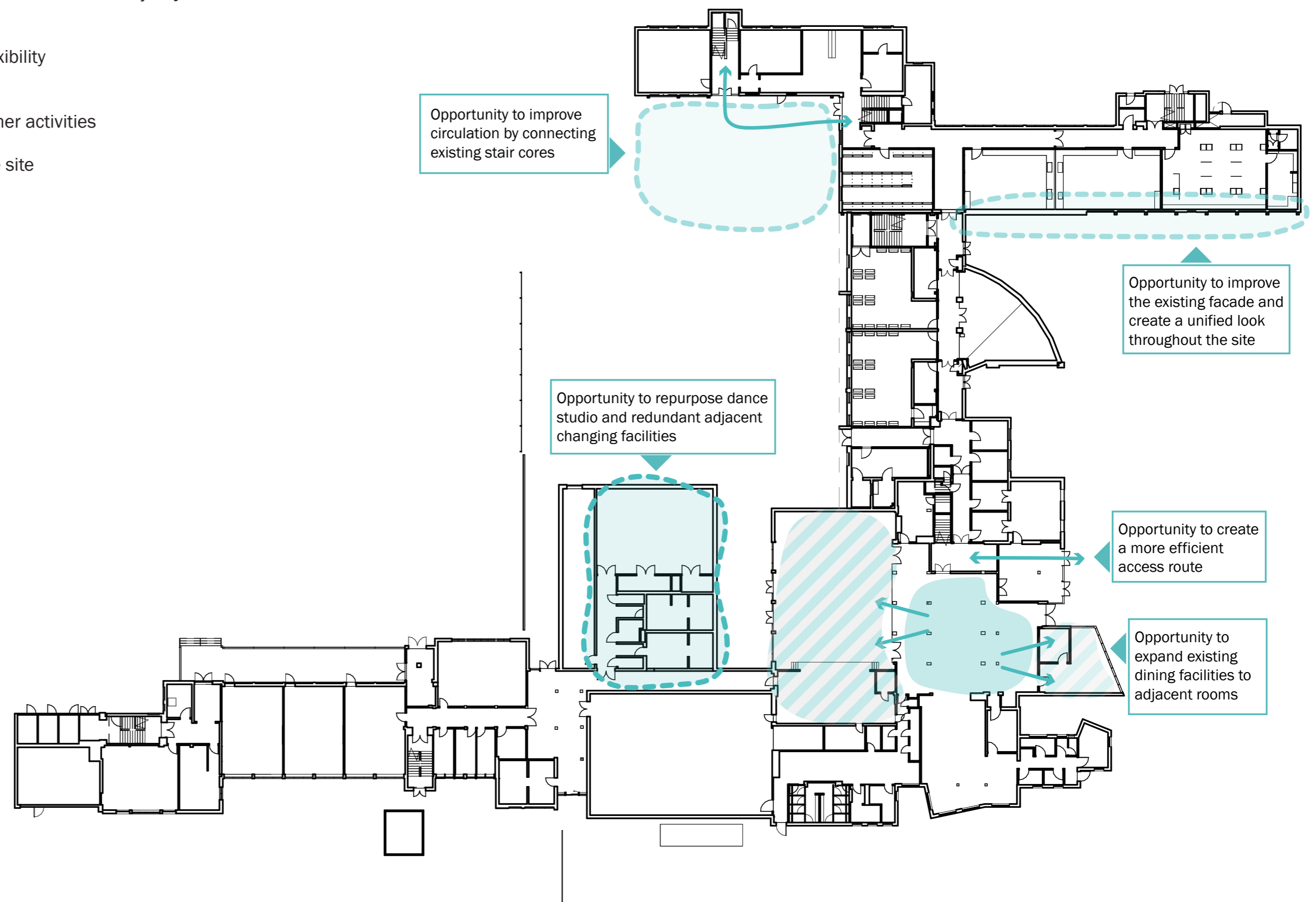

Opportunities plan

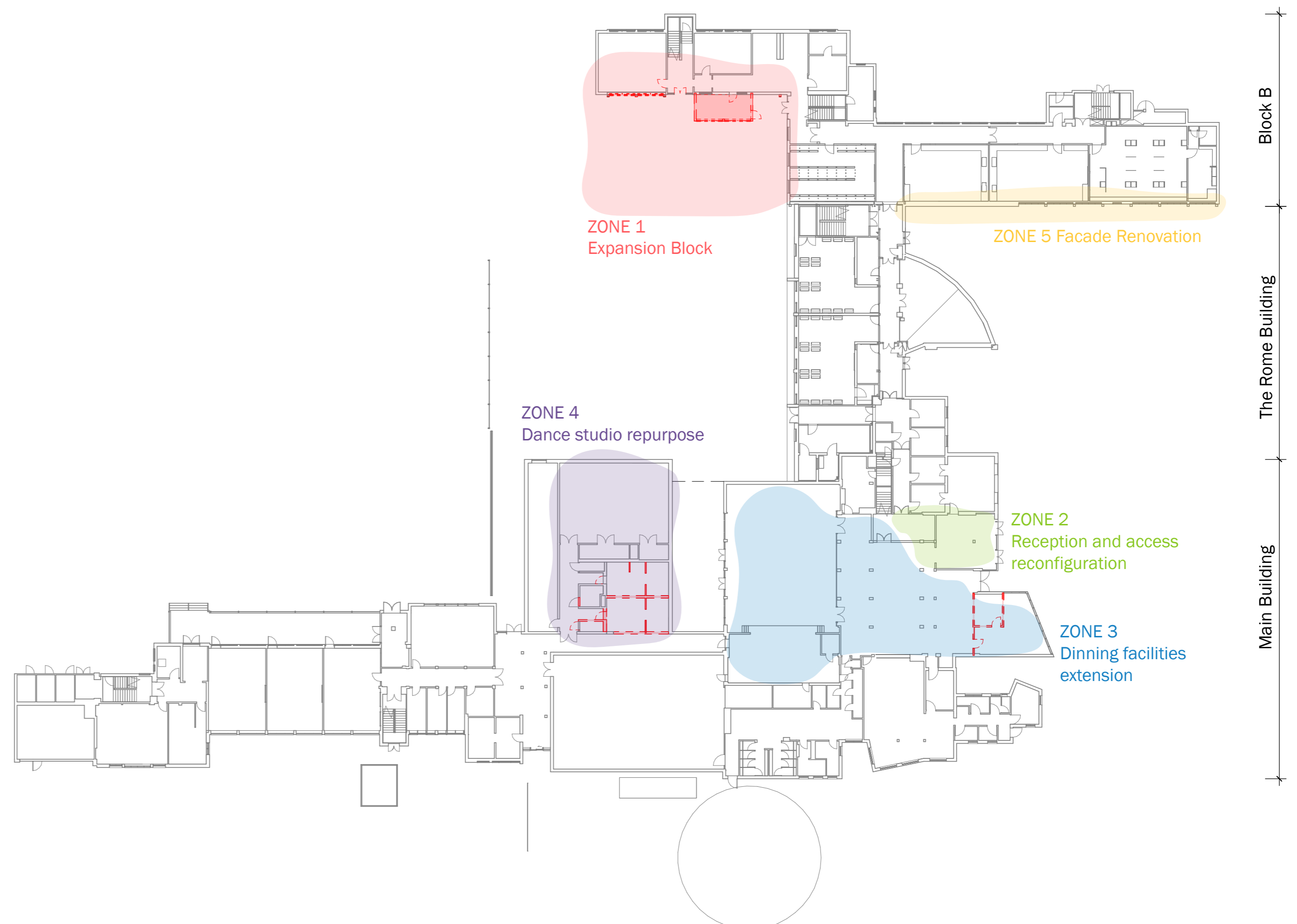

Proposed Areas of intervention

**● ZONE 1 EXPANSION BLOCK**

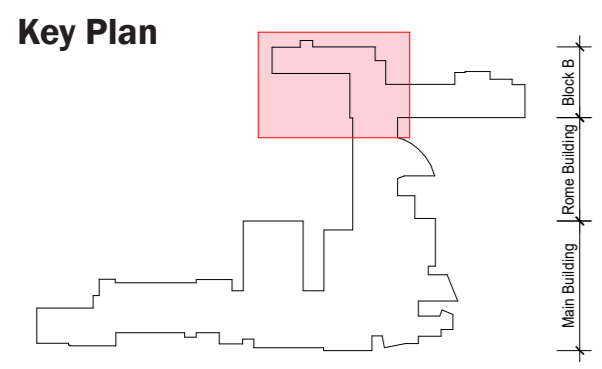

The expansion block consists of a three storey building raised on columns, with a landscaped undercroft below. Elevating the block releases the ground floor to create a covered outdoor space for the students to socialize. Modular furniture and planting will be used to create a relaxed and social atmosphere in the undercroft area.

Above, each of the floors comprise two additional classrooms. The first floor includes the refurbishing of the existing History Classroom and an additional Staff Office. On the second floor, an additional Group Room accompanies the two classrooms. And, on the third floor, the classrooms can be opened up to create a flexible open space for events or large group activities. This floor gives access to the existing Block B roof which is to be transformed into a green roof.

Additionally, several of the existing spaces at ground floor level are to be refurbished to provide additional pupil toilets, an office for the staff members and an additional Digital Technology Classroom.

**CONCEPT DEVELOPMENT**

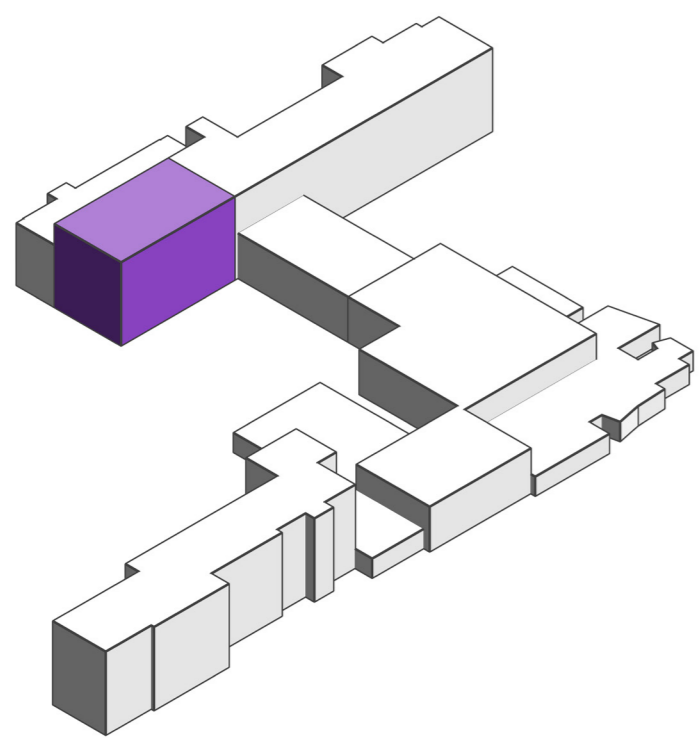

**Block Placement**

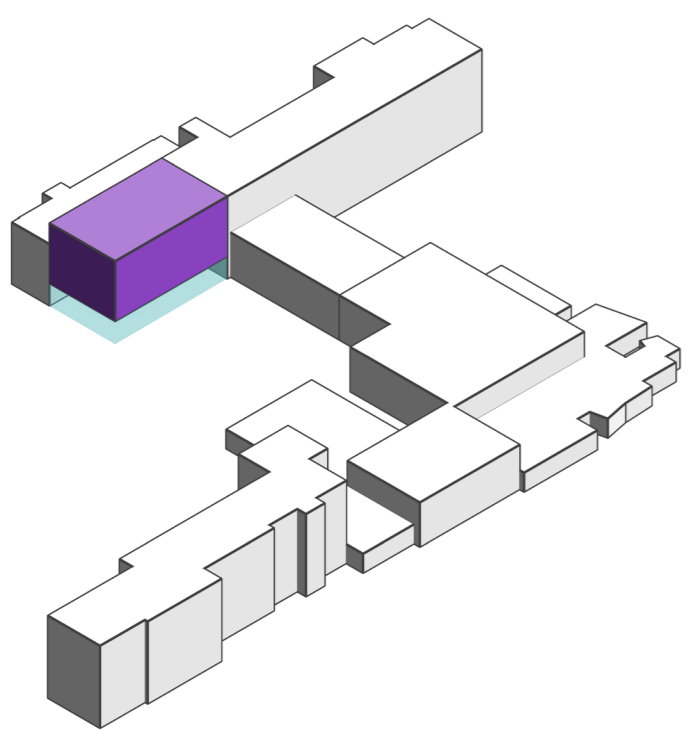

**Free the ground**

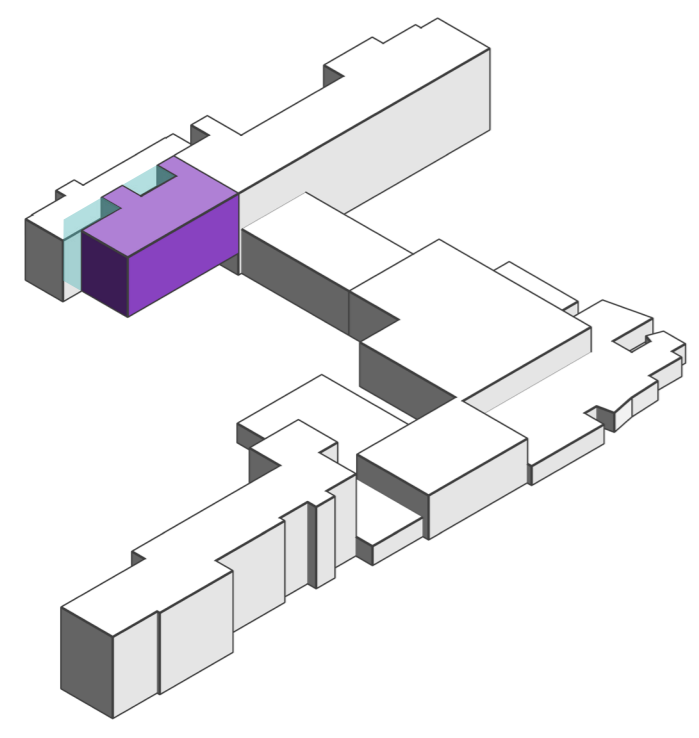

**Allow natural light**

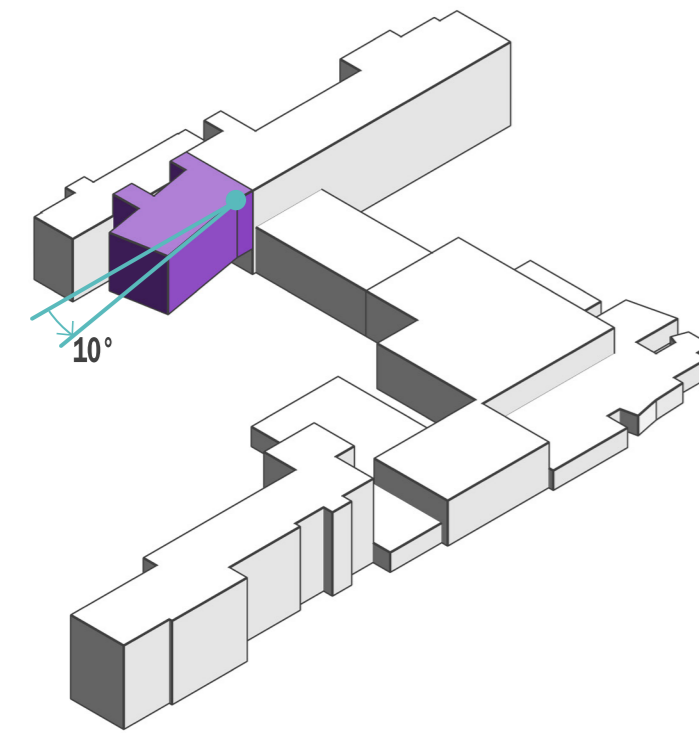

**Rotate 10 degrees for more natural light**

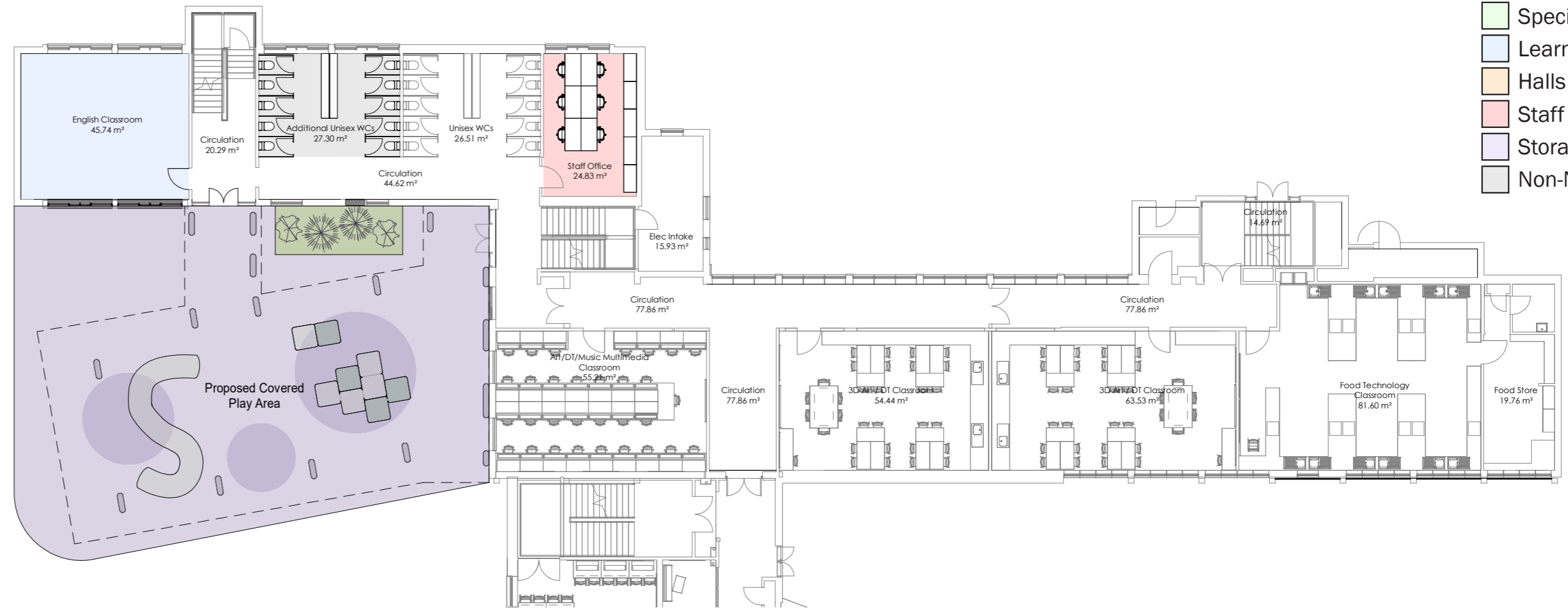

**Proposed Ground Floor Plan**



**ACCOMMODATION LEGEND**

- Basic Teaching
- Specialist Teaching
- Learning Resource
- Halls and Dining
- Staff and Admin
- Storage
- Non-Net

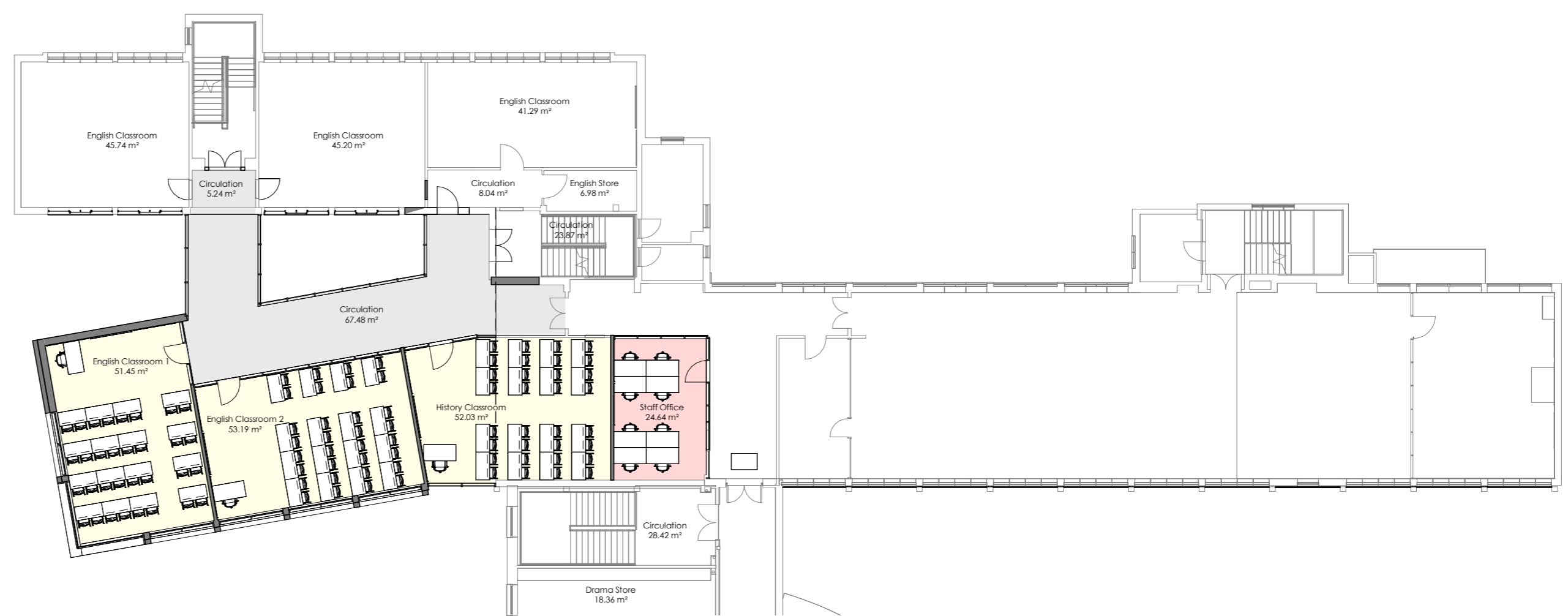

**Proposed First Floor Plan**

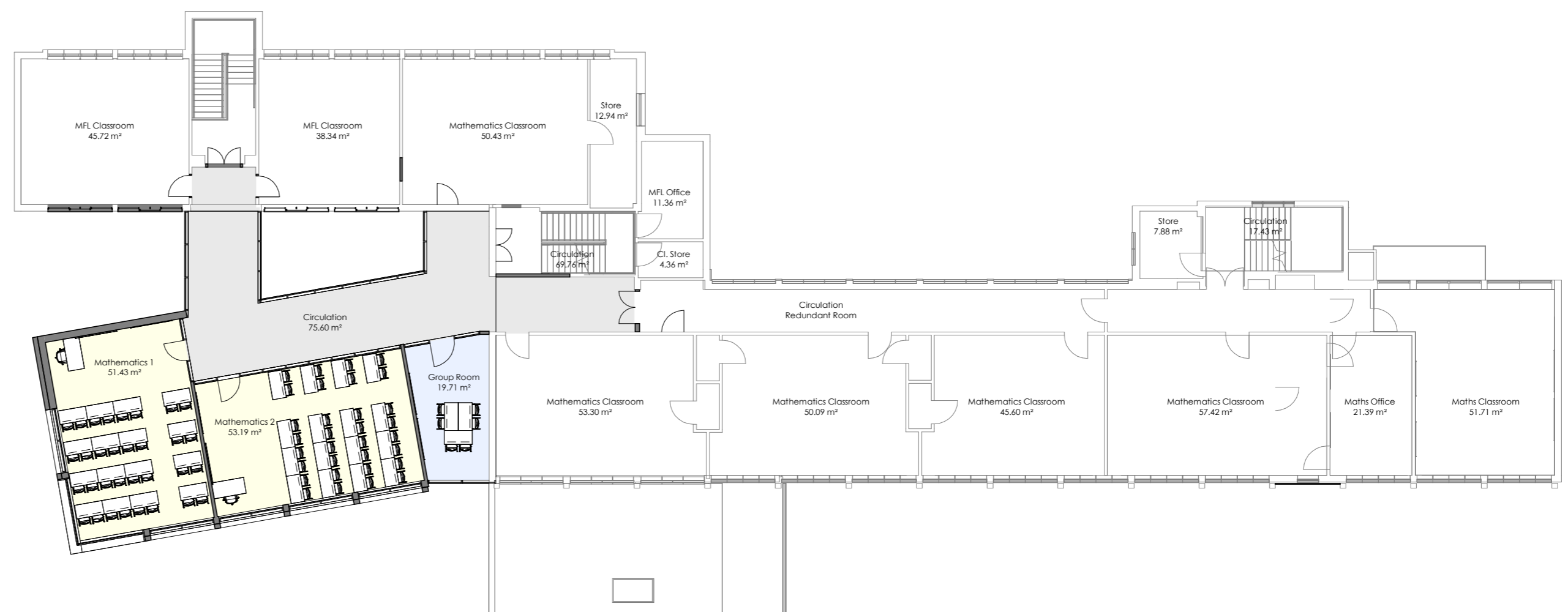

**Proposed Second Floor Plan**

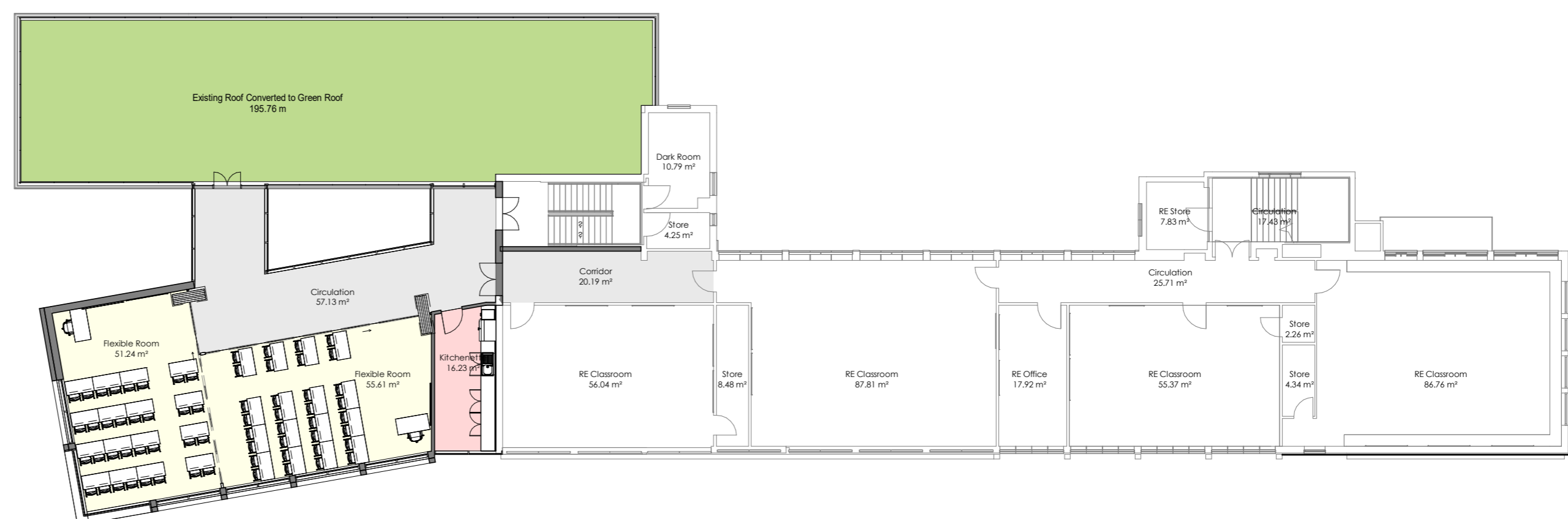

**Proposed Third Floor Plan**

**● ZONE 1 EXPANSION BLOCK - EXPLODED AXONOMETRIC**

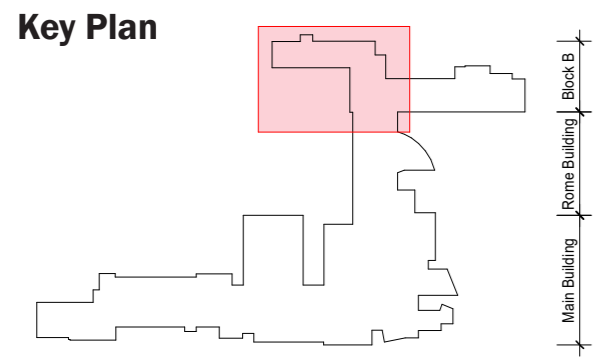

**KEY PROVISION**

- ① English Classroom
- ② History Classroom
- ③ Mathematics Classroom
- ④ Group Room
- ⑤ Flexible space
- ⑥ Kitchenette
- ⑦ Green Roof

**ACCOMMODATION LEGEND**

- Basic Teaching
- Specialist Teaching
- Learning Resource
- Halls and Dining
- Staff and Admin
- Storage
- Non-Net

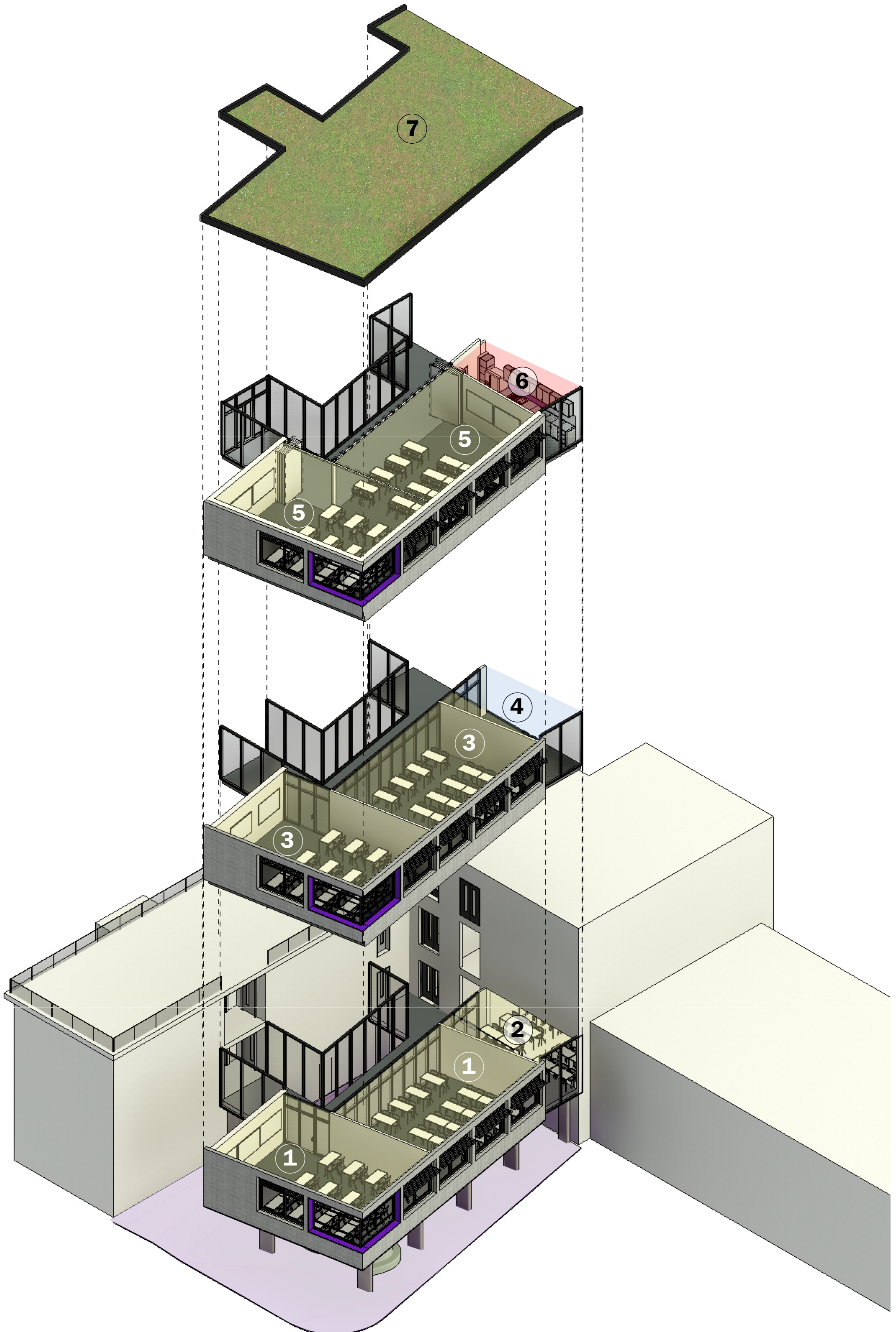

Proposed Exploded Axonometric of Expansion Block

● ZONE 1 EXPANSION BLOCK - EXTERNAL APPEARANCE



Proposed West Elevation

Proposed South Elevation



THE ROYAL BOROUGH OF  
KENSINGTON  
AND CHELSEA



ALL SAINTS  
CATHOLIC COLLEGE  
ORARE LABORARE SERVIRE

**● ● ● ZONE 2-4 RECEPTION, DINNING HALL AND STUDENT SERVICES**

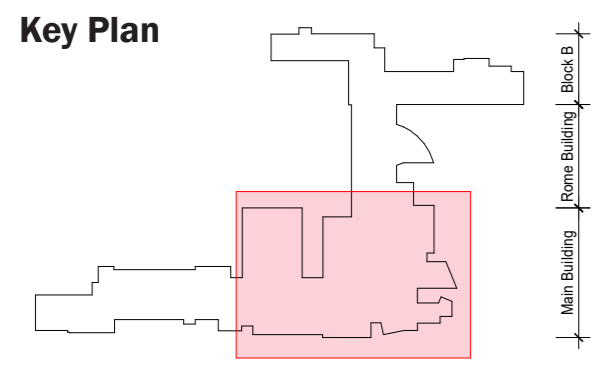

- Zone 2 involves the rearrangement and refurbishment of the reception space to make the access to the building more efficient. Rearrangement and refurbishment of the reception space will direct traffic through the existing circulation space rather than through the dining hall as per the current arrangement. Foot traffic through the dining hall will therefore be reduced and the space allowed to operate more effectively.
- Zone 3 involves the expansion of the dining area to occupy the adjacent main hall and the student services space to ensure there is adequate dining area to meet the new capacity requirements. Utilising the adjacent spaces will also provide the students with a variety of seating options.
- Zone 4 involves the relocation of the student services room and provision of an additional staff toilet, staff shower and a medical room. The existing redundant changing facilities within the centre of the school are to be re-purposed and the existing toilet facilities refurbished.

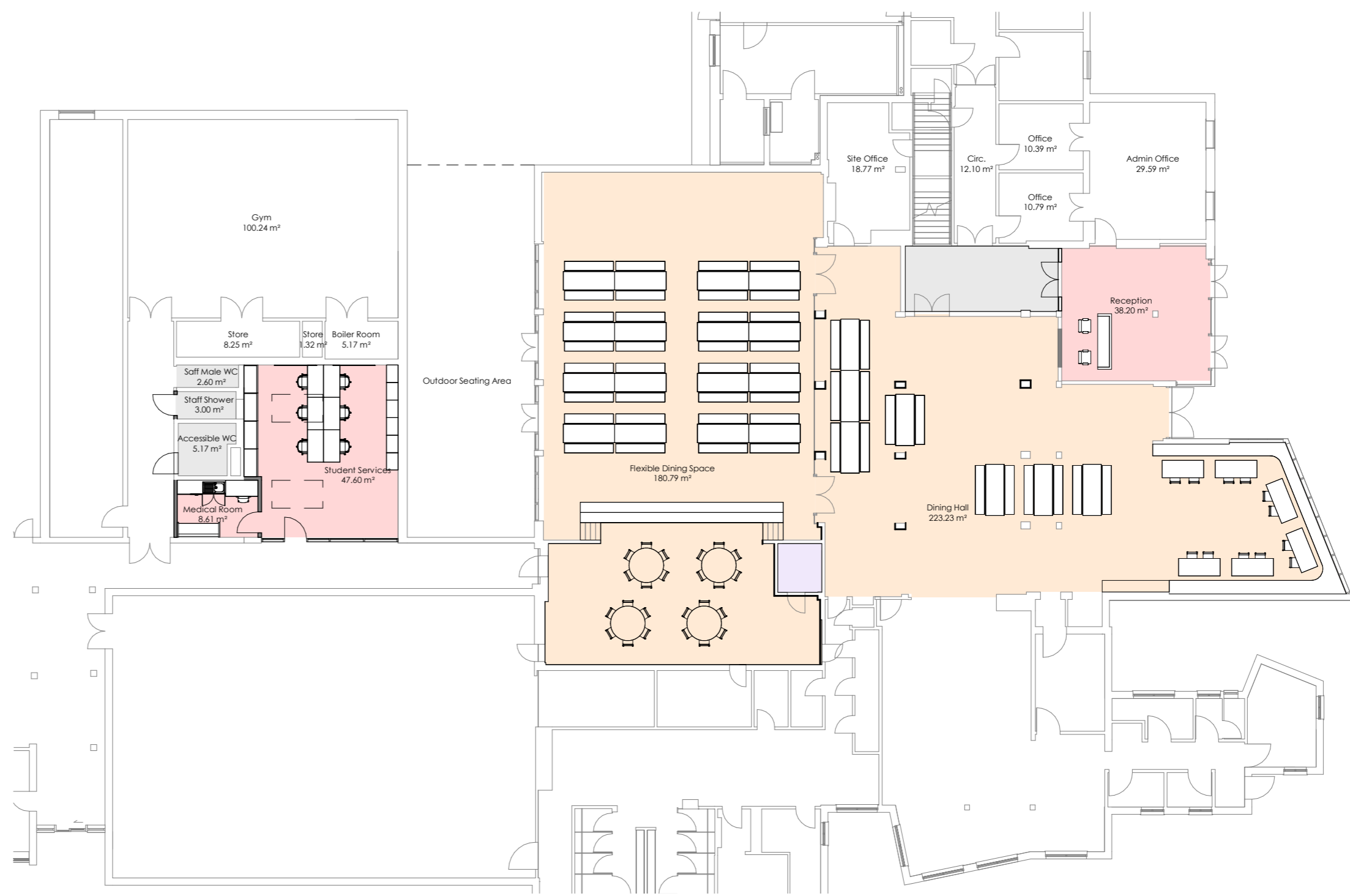

**ACCOMMODATION LEGEND**

- Basic Teaching
- Specialist Teaching
- Learning Resource
- Halls and Dining
- Staff and Admin
- Storage
- Non-Net

**Proposed Ground Floor Plan - Main Building**



**● Dining Hall Expansion Visual**

**ZONE 5 - FACADE REFURBISHMENT**

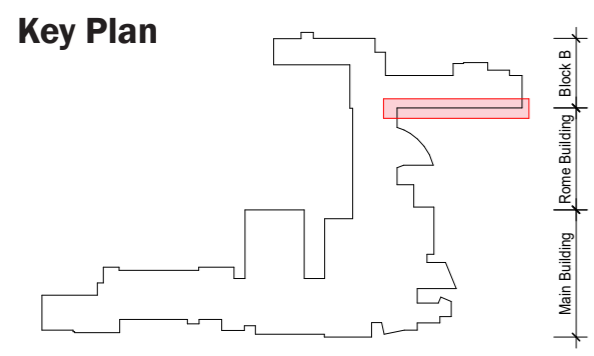

Zone 5 involves the renovation of the south facade of Block B to address existing condition issues whilst achieving a unified appearance between the existing building and proposed expansion block.

Brickwork elements of the facade are due to be reclad with brick slips. It is proposed that a mixture of grey and purple brick slips will be used to add vibrancy to the dated appearance of the existing facade, whilst strengthening the architectural relationship of the Block B south elevation, the proposed expansion block and recently completed 'Rome Building'.

The soffits, window frames and sills are to be redecorated to further unify the appearance of the buildings on site and the existing columns are to be clad with a light grey cement board.

**MATERIAL PALETTE**

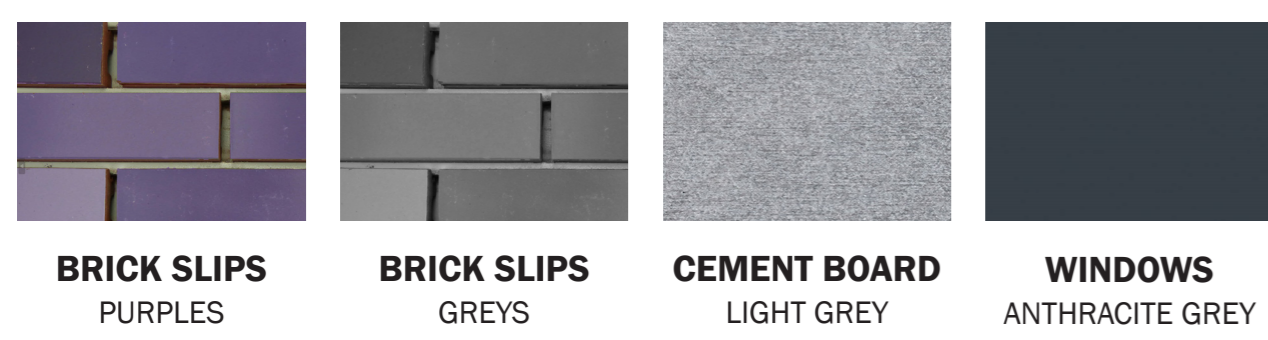

**UNIFIED APPEARANCE**



Existing 'Rome' Building



Proposed 1FE Expansion Block



Proposed block B south elevation

